

800 to 7000MHz Drop in Circulator

WH1313M Strip Line Type

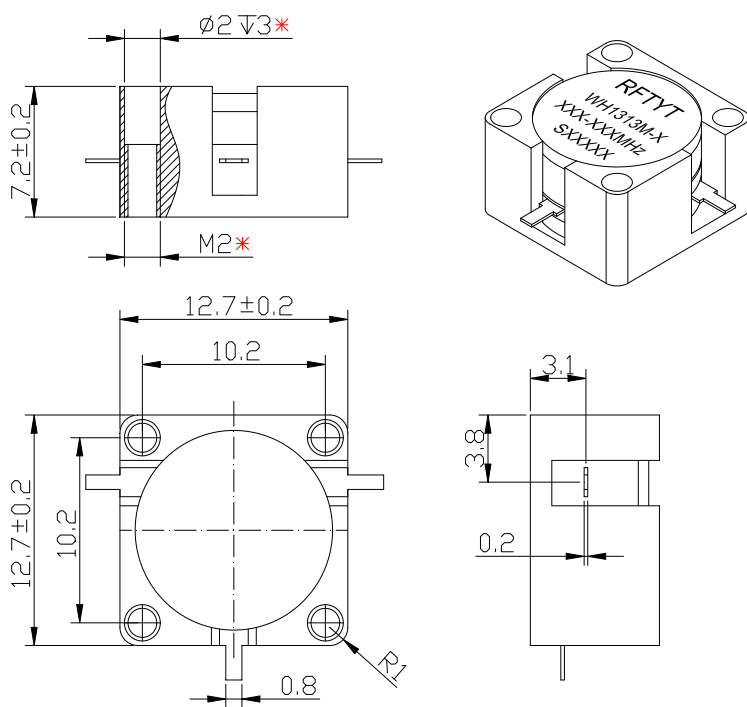

Outline Drawing (mm):



Features:

- ◇ Good temperature stability
- ◇ Withstand high power
- ◇ RoHS compliant
- ◇ Weight : ≈ 6 g

Material list:

- ◇ Shell: easy to cut iron plated nickel
- ◇ Inner guide body: brass

Application:

- ◇ Rf amplifier final stage, protect the amplifier
- ◇ Common transceiver antenna
- ◇ Digital communication
- ◇ Satellite communication
- ◇ Mobile communication

Order Examples:

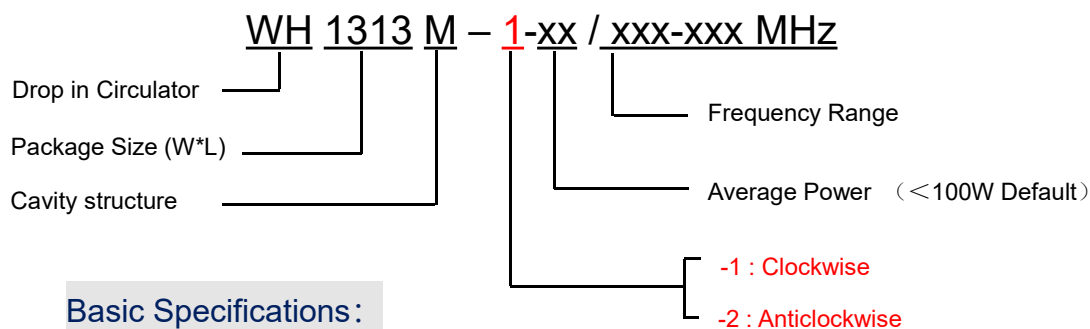

Basic Specifications :

Impedance	50 Ω
Operating temperature	-30~+70°C / -40~+85°C
Storage temperature	-50~+90 °C
Size(mm)	12.7*12.7*7.2



Specifications:

Model No (X=1: →Clockwise) (X=1: →Clockwise)	Freq. Range MHz	Insertion Loss dB (max)	Isolation dB (min)	VSWR (max)	Power W
WH1313M-X/800-830MHz	800-830	0.40	20.0	1.25	50
WH1313M-X/930-960MHz	930-960	0.40	20.0	1.25	50
WH1313M-X/1230-1250MHz	1230-1250	0.40	20.0	1.25	50
WH1313M-X/1285-1315MHz	1285-1315	0.30	23.0	1.20	50
WH1313M-X/1330-1390MHz	1330-1390	0.50	19.0	1.25	50
WH1313M-X/1427-1517MHz	1427-1517	0.40	18.0	1.30	50
WH1313M-X/1565-1585MHz	1565-1585	0.30	23.0	1.20	50
WH1313M-X/1610-1620MHz	1610-1620	0.30	23.0	1.20	50
WH1313M-X/1710-1785MHz	1710-1785	0.40	20.0	1.25	50
WH1313M-X/1805-1880MHz	1805-1880	0.40	20.0	1.25	50
WH1313M-X/1805-1920MHz	1805-1920	0.50	19.0	1.25	50
WH1313M-X/1880-1920MHz	1880-1920	0.30	23.0	1.20	50
WH1313M-X/1920-1990MHz	1920-1990	0.30	23.0	1.20	50
WH1313M-X/2110-2170MHz	2110-2170	0.30	23.0	1.20	50
WH1313M-X/2200-2400MHz	2200-2400	0.40	20.0	1.25	50
WH1313M-X/2300-2400MHz	2300-2400	0.30	23.0	1.20	50
WH1313M-X/2300-2500MHz	2300-2500	0.40	20.0	1.25	50
WH1313M-X/2400-2500MHz	2400-2500	0.30	23.0	1.20	50
WH1313M-X/2400-2600MHz	2400-2600	0.40	20.0	1.25	50
WH1313M-X/2496-2690MHz	2496-2690	0.40	20.0	1.25	50
WH1313M-X/2500-2700MHz	2500-2700	0.40	20.0	1.25	50
WH1313M-X/2670-2690MHz	2670-2690	0.30	23.0	1.20	50
WH1313M-X/2700-2900MHz	2700-2900	0.30	20.0	1.25	50
WH1313M-X/2700-3100MHz	2700-3100	0.40	19.0	1.25	50
WH1313M-X/2900-3100MHz	2900-3100	0.30	20.0	1.25	50
WH1313M-X/2900-3300MHz	2900-3300	0.40	20.0	1.25	50



Model No (X=1: →Clockwise) (X=1: →Clockwise)	Freq. Range MHz	Insertion Loss dB (max)	Isolation dB (min)	VSWR (max)	Power W
WH1313M-X/3100-3500MHz	3100-3500	0.40	20.0	1.25	50
WH1313M-X/3100-3600MHz	3100-3600	0.50	19.0	1.25	50
WH1313M-X/3250-3450MHz	3250-3450	0.30	20.0	1.20	50
WH1313M-X/3300-3500MHz	3300-3500	0.30	20.0	1.20	50
WH1313M-X/3300-3600MHz	3300-3600	0.30	20.0	1.20	50
WH1313M-X/3500-3650MHz	3500-3650	0.30	23.0	1.20	50
WH1313M-X/3700-4000MHz	3700-4000	0.30	20.0	1.20	50
WH1313M-X/3700-4200MHz	3700-4200	0.50	18.0	1.30	50
WH1313M-X/4200-4400MHz	4200-4400	0.30	23.0	1.20	50
WH1313M-X/4400-4520MHz	4400-4520	0.30	23.0	1.20	50
WH1313M-X/4400-5000MHz	4400-5000	0.50	19.0	1.25	50
WH1313M-X/4800-5000MHz	4800-5000	0.30	23.0	1.20	50
WH1313M-X/5000-5500MHz	5000-5500	0.40	20.0	1.25	50
WH1313M-X/5000-6000MHz	5000-6000	0.50	18.0	1.30	50
WH1313M-X/5100-5800MHz	5100-5800	0.45	19.0	1.25	50
WH1313M-X/5100-5900MHz	5100-5900	0.50	18.0	1.30	50
WH1313M-X/5200-5900MHz	5200-5900	0.45	19.0	1.25	50
WH1313M-X/5200-6200MHz	5200-6200	0.50	18.0	1.30	50
WH1313M-X/5300-5900MHz	5300-5900	0.40	20.0	1.25	50
WH1313M-X/5400-5900MHz	5400-5900	0.40	20.0	1.25	50
WH1313M-X/5400-6200MHz	5400-6200	0.40	19.0	1.25	50
WH1313M-X/5700-5900MHz	5700-5900	0.30	23.0	1.20	50
WH1313M-X/5500-6000MHz	5500-6000	0.40	20.0	1.25	50
WH1313M-X/5800-6700MHz	5800-6700	0.45	19.0	1.25	50
WH1313M-X/5850-6650MHz	5850-6650	0.40	20.0	1.25	50
WH1313M-X/6500-7000MHz	6500-7000	0.30	20.0	1.20	50



Instructions:

- 1, The circulator only provides through power, indicating that the transmission to the antenna and the antenna to the receiving are through power;
- 2, Only some common frequencies in the table, can be produced according to user requirements;
- 3, Embedded circulator, please use stainless steel or brass screws when installing;
- 4, If you do not find what you are looking for, please contact us!