

## EI42-14.8 6.0VA Encapsulated transformer

### FEATURES

- CQC file No.: CQC17001167224
- CE file No: BSTXD190311209301EC/BSTXD190311209301SC
- Vacuum Filling, Encapsulated Design Prevent dust and humidity
- High efficiency, Low Temperature Rise
- Dielectric Strength 4000VAC
- Class B (130° C) insulation material.
- Operating temperature from -40 ° C to 70 ° C
- Design according to EN61558-1, EN61000,GB19212-1, GB19212-7
- 100% Production Tested

### OUTLINE DIMENSIONS

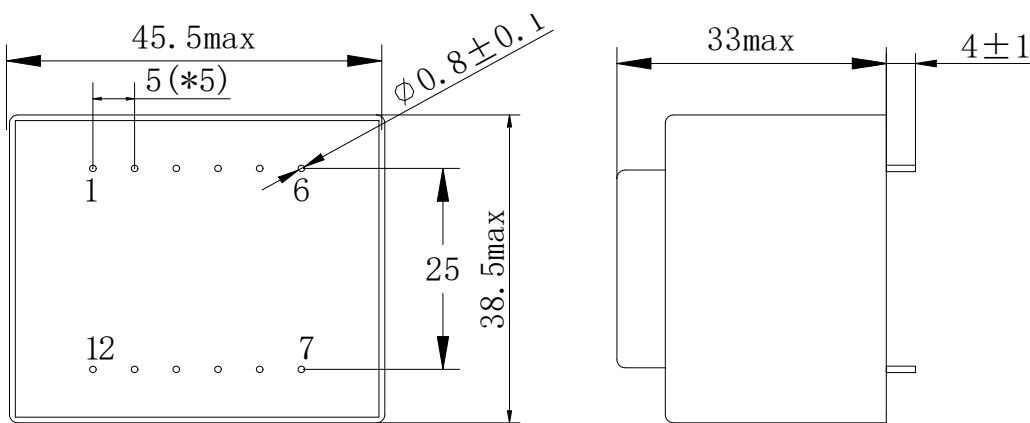

### COMMON APPLICATIONS

- Medical equipment
- Industrial equipment
- Industrial control
- Test equipment
- Industrial computer
- Avionics and Telecommunications

### SCHEMATIC DIAGRAM

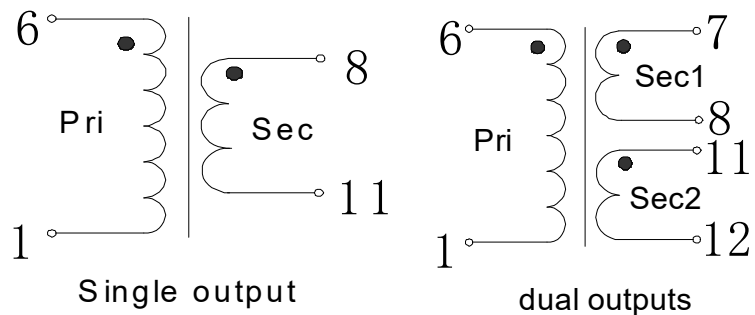

## ELECTRONIC SPECIFICATIONS:

PART NO	Primary [V]	Secondary [V]	Current [mA]	Ambient TEMP.(°C)	Weight (g)	Certificate			
						VDE	UL	CQC	CE
XP421-816	115V 50/60Hz	4.5V	1333mA	T40 B	200		•		•
XP421-817	115V 50/60Hz	6V	1000mA	T40 B	200		•		•
XP421-818	115V 50/60Hz	7.5V	800mA	T40 B	200		•		•
XP421-819	115V 50/60Hz	9V	666mA	T40 B	200		•		•
XP421-820	115V 50/60Hz	12V	500mA	T40 B	200		•		•
XP421-821	115V 50/60Hz	15V	400mA	T40 B	200		•		•
XP421-822	115V 50/60Hz	18V	333mA	T40 B	200		•		•
XP421-823	115V 50/60Hz	24V	250mA	T40 B	200		•		•
XP422-824	115V 50/60Hz	2x4.5V	2x666mA	T40 B	200		•		•
XP422-825	115V 50/60Hz	2x6V	2x500mA	T40 B	200		•		•
XP422-826	115V 50/60Hz	2x7.5V	2x400mA	T40 B	200		•		•
XP422-827	115V 50/60Hz	2x9V	2x333mA	T40 B	200		•		•
XP422-828	115V 50/60Hz	2x12V	2x250mA	T40 B	200		•		•
XP422-829	115V 50/60Hz	2x15V	2x200mA	T40 B	200		•		•
XP422-830	115V 50/60Hz	2x18V	2x166mA	T40 B	200		•		•
XP422-831	115V 50/60Hz	2x24V	2x125mA	T40 B	200		•		•
XP421-916	230V 50/60Hz	4.5V	1333mA	T40 B	200		•	•	•
XP421-917	230V 50/60Hz	6V	1000mA	T40 B	200		•	•	•
XP421-918	230V 50/60Hz	7.5V	800mA	T40 B	200		•	•	•
XP421-919	230V 50/60Hz	9V	666mA	T40 B	200		•	•	•
XP421-920	230V 50/60Hz	12V	500mA	T40 B	200		•	•	•
XP421-921	230V 50/60Hz	15V	400mA	T40 B	200		•	•	•
XP421-922	230V 50/60Hz	18V	333mA	T40 B	200		•	•	•
XP421-923	230V 50/60Hz	24V	250mA	T40 B	200		•	•	•
XP422-924	230V 50/60Hz	2x4.5V	2x666mA	T40 B	200		•	•	•
XP422-925	230V 50/60Hz	2x6V	2x500mA	T40 B	200		•	•	•
XP422-926	230V 50/60Hz	2x7.5V	2x400mA	T40 B	200		•	•	•
XP422-927	230V 50/60Hz	2x9V	2x333mA	T40 B	200		•	•	•
XP422-928	230V 50/60Hz	2x12V	2x250mA	T40 B	200		•	•	•
XP422-929	230V 50/60Hz	2x15V	2x200mA	T40 B	200		•	•	•
XP422-930	230V 50/60Hz	2x18V	2x166mA	T40 B	200		•	•	•
XP422-931	230V 50/60Hz	2x24V	2x125mA	T40 B	200		•	•	•